

9 Number in order.

STORY

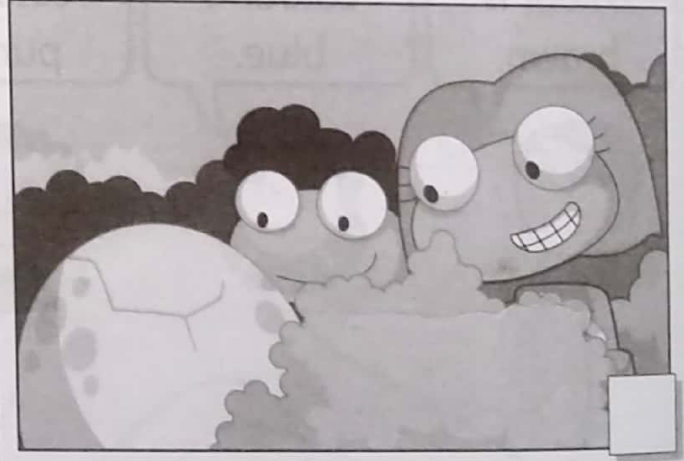
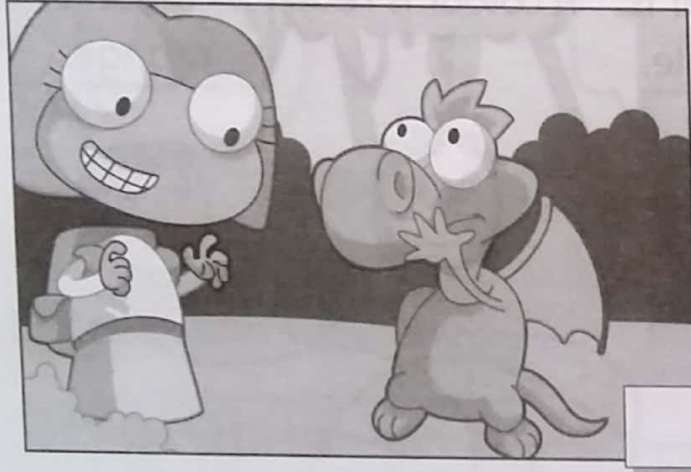
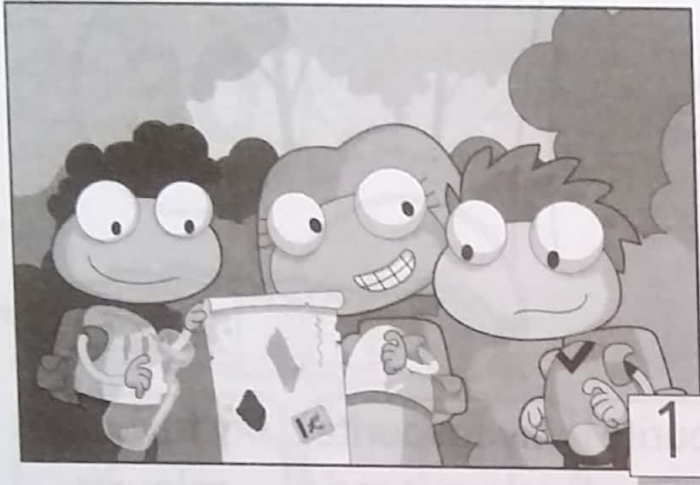
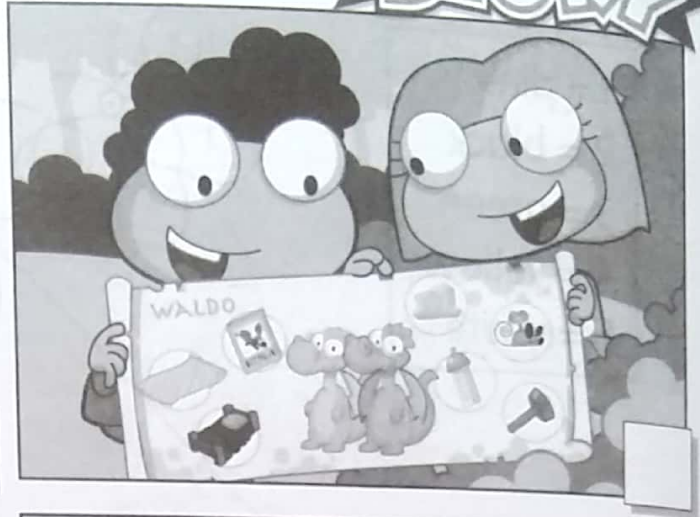
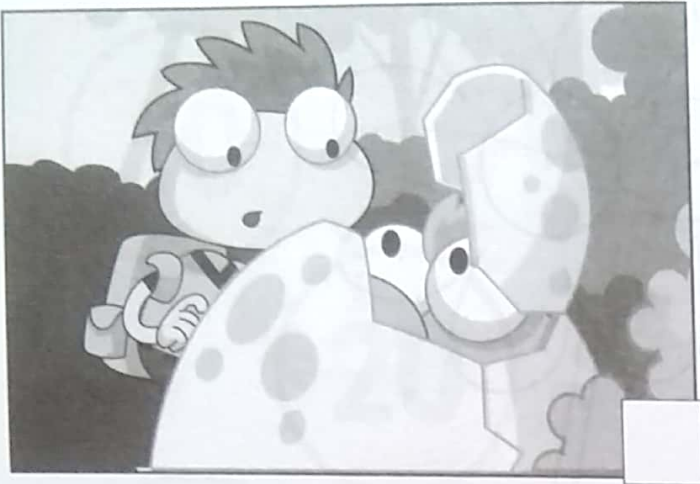

10 Read and match.

- Look. It's an egg!
- Hello. I'm Zak.
- Waldo!

- Mum?
- Look! It's a note! 1
- It's a dragon.

Unit Review

11 Look and write.

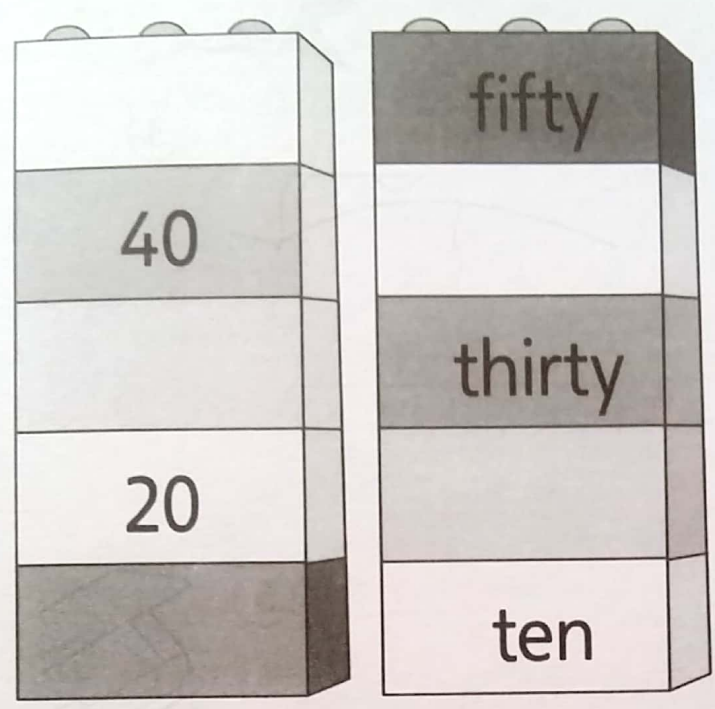

12 Read and complete. Colour.



My name's _____.
My favourite colour is purple.

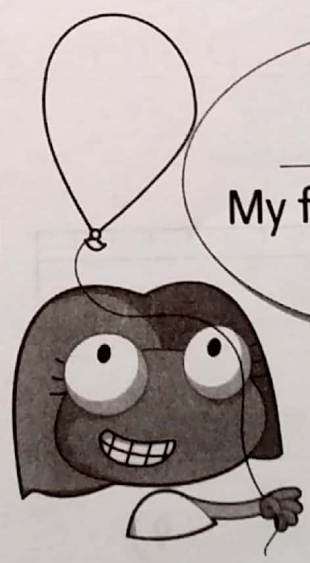

My name's _____.
My favourite colour is green.

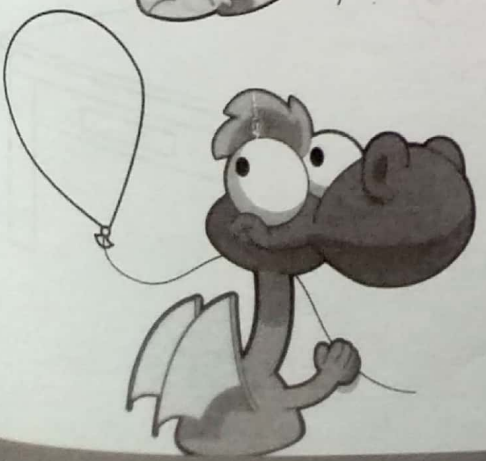

My name's _____.
My favourite colour is brown!

1 At school

VOCABULARY

1 Draw. Then trace.

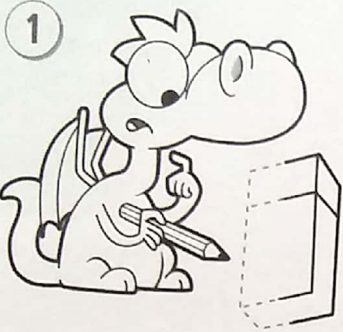

eraser

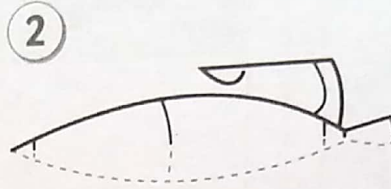

pen

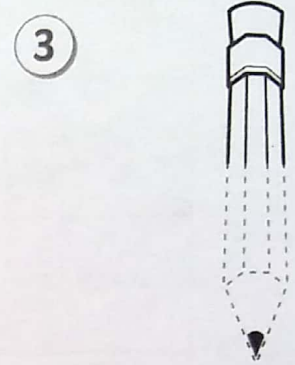

pencil

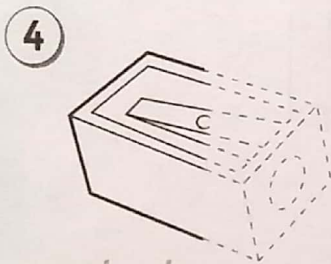

pencil sharpener

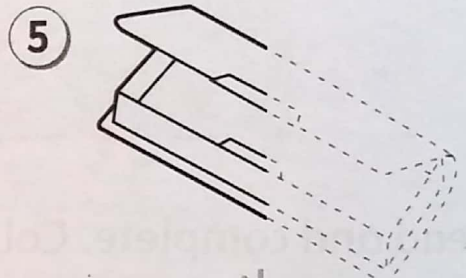

pencil case

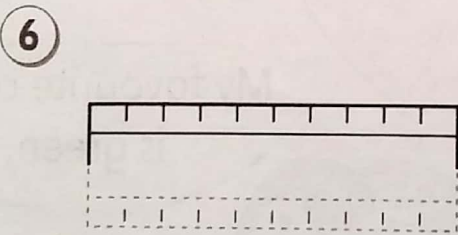

ruler

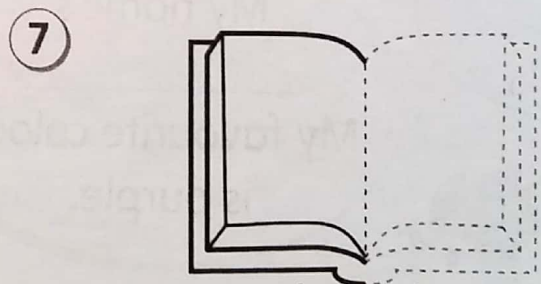

book

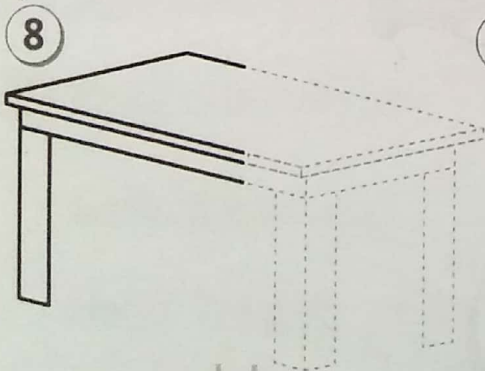

table

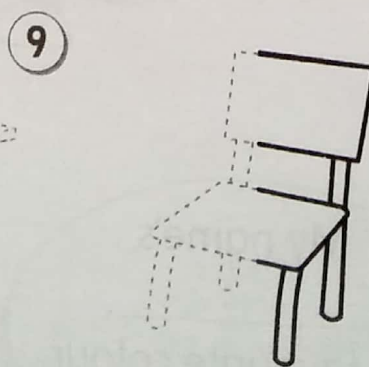

chair

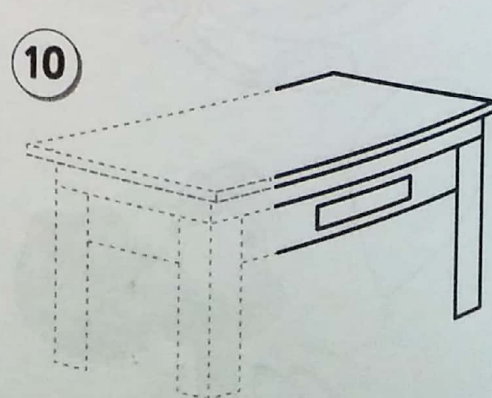

desk