

# VOCABULARY

6 Listen and repeat.

a  bed  
 b  cooker  
 c  sofa  
 d  TV  
 e  lamp  
 f  fridge  
 g  bath  
 h  sink

7 Listen and write. Then sing.

bath bathroom garden house bed bedroom

Where's the mouse?  
Where's the mouse?  
Where's the mouse?  
Where's the mouse?

Is it in the garden?  
Or is it in the house?

Is it in the garden?  
Or is it in the house?

Look! It's in the garden.  
Running up the path.

Look! It's in the garden.  
Hiding in the shed.

Now it's in the bathroom.  
Or is it in the bedroom.

Oh no! It's in the bath.  
Oh no! It's in my bed.





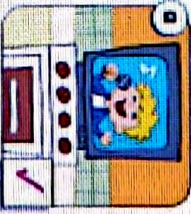

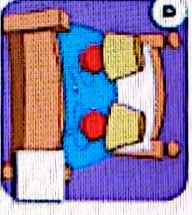
8 Listen and tick (✓).  
Then say.



1  a  b



2  a  b

**LOOK!**  
Where are ...? They're in the ...  
In the (kitchen) there is/are ...

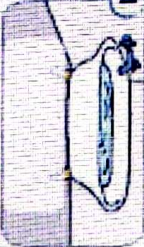
on   
 under   
 in   
 next to   
 behind 

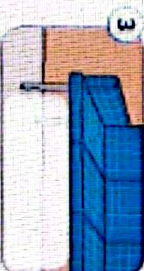
9 Listen and draw. Then play.

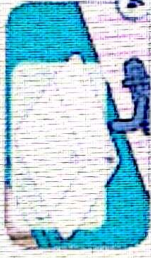
1  2  3 

4  5  6 

Where's the TV?  
It's on the cooker.

There are two books on the table.  
Number 6. My turn.

# LOOK!

# GRAMMAR

Do you live in a (flat)?	Yes, I do. / No, I don't.
Where do you live?	I live in (Cairo). I live in a (flat).
Where's (Rita)?	She's in the (kitchen).

garden



bedroom



flat



bathroom



## quest

Look for soap today.  
An egg, a blanket, a torch, a book, milk, a bed and soap!  
Look for soap today!

4 Listen and write (✓) or (X). Then say.



Where's Waldo?

He's in the bathroom.

5 Ask and answer.

Where do you live?

I live in Cairo.

Do you live in a house?

No, I don't.

# 6 My house

## VOCABULARY

1 Draw. Then write.

bathroom bedroom garden kitchen living room house flat

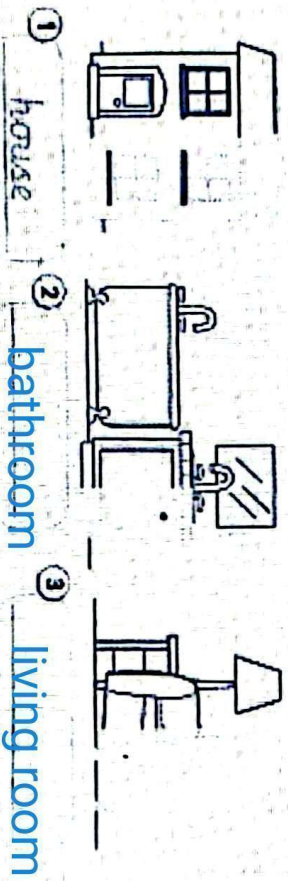

2 Read and match.

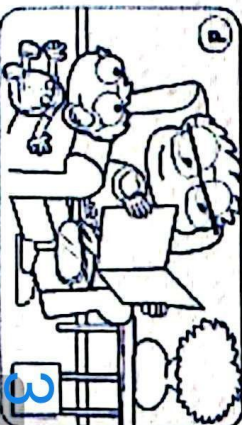
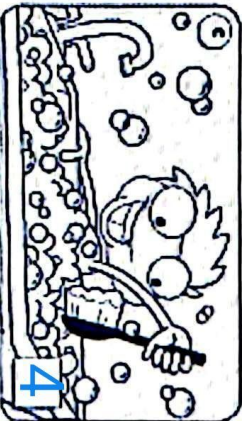
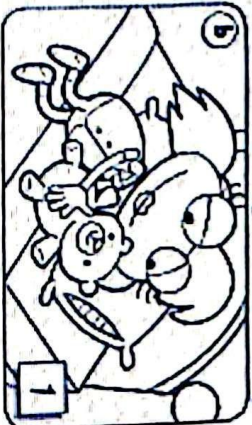
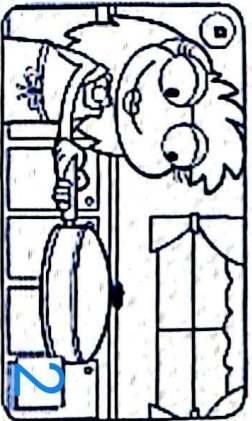

- 1 Where's Rita?  
She's in the bedroom.
- 2 Where's my mum?  
She's in the kitchen.
- 3 Where are Yoyo and my dad?  
They're in the living room.
- 4 Where's Zaki?  
He's in the bathroom.

3 Join the dots. Then write.

Where is Waldor?

He's in the living room.

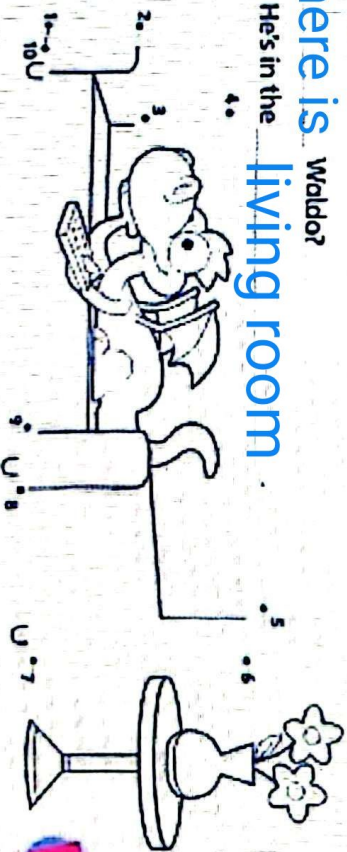

# VOCABULARY

Look and write.

cooker TV sink lamp bed sofa fridge bath

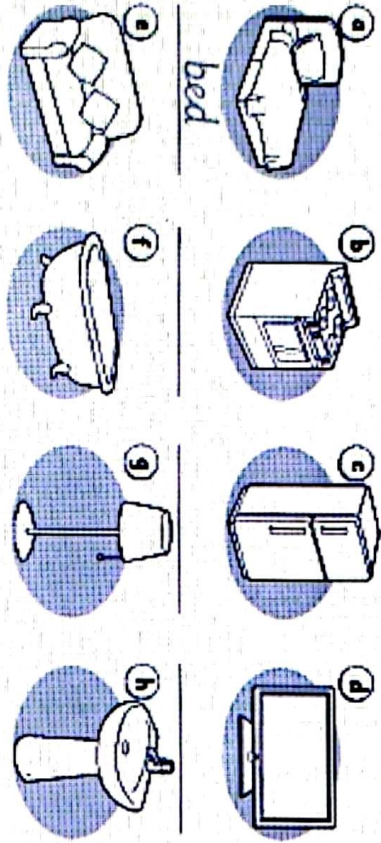

Look, read and write.

bathroom garden bedroom

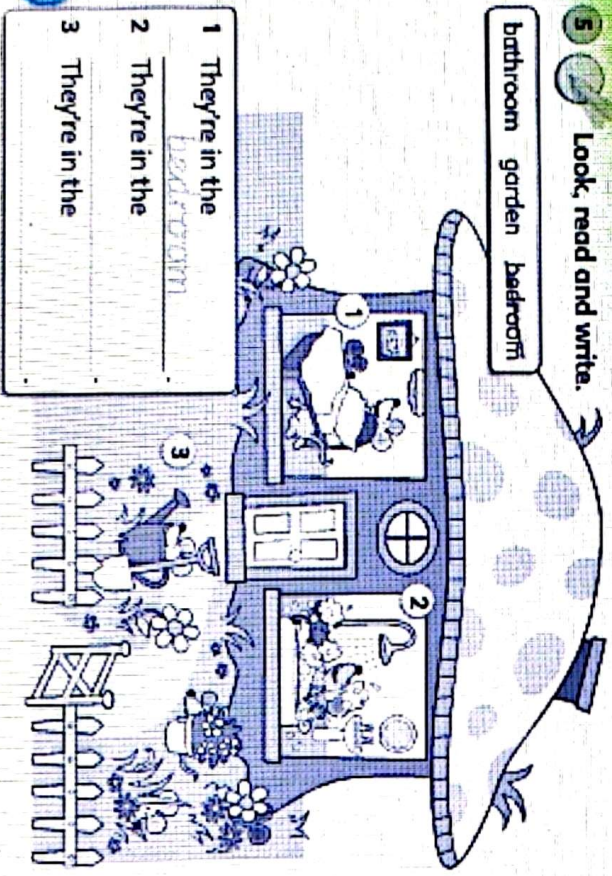

- 1 They're in the bedroom
- 2 They're in the \_\_\_\_\_
- 3 They're in the \_\_\_\_\_

Read and find. Then write and circle.

# GRAMMAR

art under next to behind in

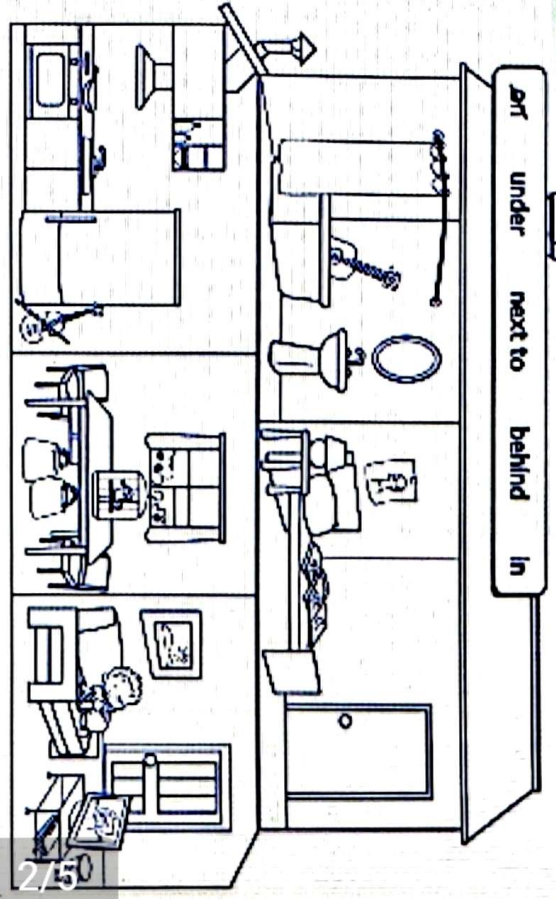

- 1 Where's the lamp?  
The lamp is on the table / chair.
- 2 Where are the bags?  
The bags are \_\_\_\_\_ the table / sofa.
- 3 Where's the guitar?  
The guitar is \_\_\_\_\_ the bath / fridge.
- 4 Where's the violin?  
The violin is \_\_\_\_\_ the cooker / fridge.
- 5 Where are the drums?  
The drums are \_\_\_\_\_ the sink / TV.